

DINING ROOM & BEDROOM DESCRIPTIVE INVENTORY

CONTRACTOR OR CARRIER	AGENT	CARRIER'S REFERENCE NO.
OWNER'S GRADE OR RATING AND NAME		CONTRACT OR GBL NO.
ORIGIN LOADING ADDRESS		GOV'T SERVICE ORDER NO.
CITY		STATE
DESTINATION		VAN NO.

EXCEPTION SYMBOLS

- | | | | |
|----------------|--------------|-------------|----------------|
| W - BADLY WORN | CH - CHIPPED | L - LOOSE | RU - RUSTED |
| BE - BENT | Z - CRACKED | M - MARRED | SC - SCRATCHED |
| BR - BROKEN | D - DENTED | MI - MILDEW | SH - SHORT |
| BU - BURNED | F - FADED | P - PITTED | SO - SOILED |
| C - CAVED | G - GOUGED | R - RUBBED | T - TORN |

LOCATION SYMBOLS

- | | | | |
|-----------|----------|------------|--------------|
| 1. ARM | 6. LEGS | 11. VENEER | 16. DRAWER |
| 2. BOTTOM | 7. REAR | 12. EDGE | 17. DOOR |
| 3. CORNER | 8. RIGHT | 13. CENTER | 18. SHELF |
| 4. FRONT | 9. SIDE | 14. INSIDE | 19. HARDWARE |
| 5. LEFT | 10. TOP | 15. SEAT | |

Double/Triple Dresser
Remarks:

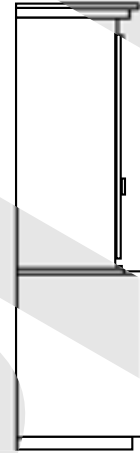
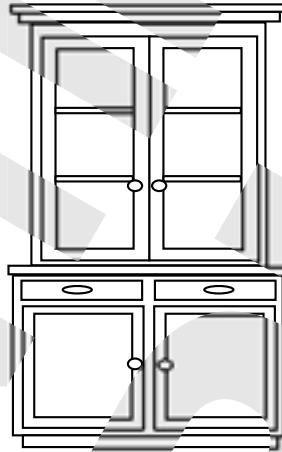
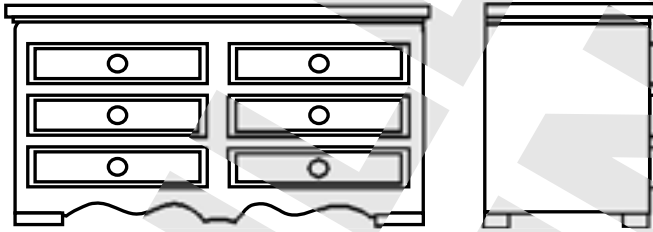

China Cabinet/Hutch
Remarks:

Night Stand
Remarks:

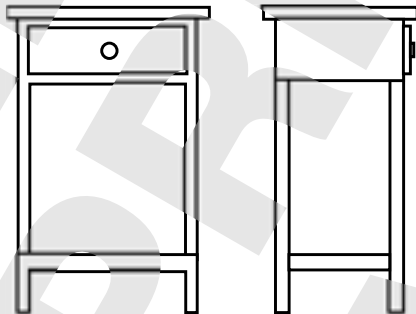

Armoire/Chest
Remarks:

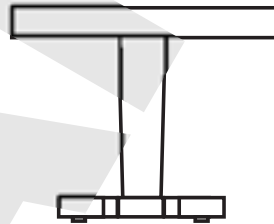
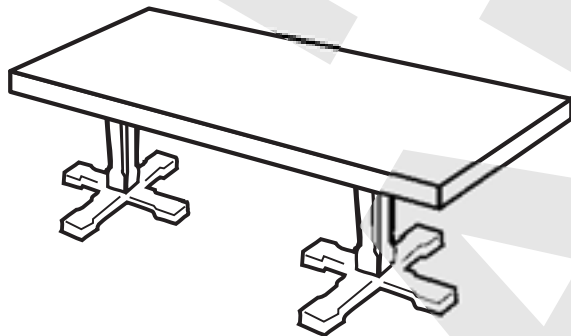
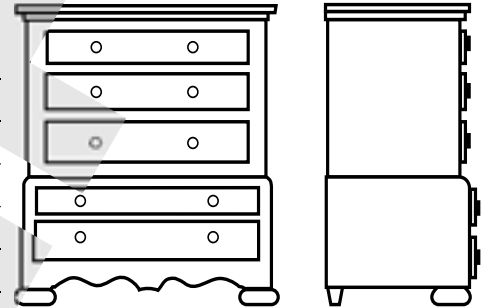

Dining Table
Remarks:

THIS SPACE TO BE USED FOR DESTINATION EXCEPTIONS BY OWNER ONLY!

EXCEPTIONS (IF ANY) AT DESTINATION:

"We have checked the items listed and acknowledge that this is the state of the goods received."

AT ORIGIN	CARRIER OR AUTHORIZED AGENT (DRIVER)	DATE	AT DESTINATION	CARRIER OR AUTHORIZED AGENT (DRIVER)	DATE
	(SIGNATURE)			(SIGNATURE)	
	OWNER OR AUTHORIZED AGENT	DATE		OWNER OR AUTHORIZED AGENT	DATE
	(SIGNATURE)			(SIGNATURE)	